

DUO

Wall mounted recept.

Part No.: 5604506G



MENNEKES

Elektrotechnik GmbH & Co. KG
Aloys-Mennekes-Straße 1
57399 KIRCHHUNDEM GERMANY
www.MENNEKES.de

Product Description

- Screw terminals
- Pre-wired for installation
- X-CONTACT®
- Switched
- Mechanical DUO interlock
- 3 pole switch
- Sockets can be padlocked

Technical Details

DUO - Wall mounted receptacle	5604506G
Product series	DUO
Switch Disconnecter	Yes
Ampere	32 A
Number of Poles	5
Clock position	6 h
Voltage	400 V
Hertz	50-60 Hz
Current Type	AC
Switch type	3P + N + PE
Protection Type	IP67
Impact resistance	IK08
Mounting method	Wall mounted
Pilot contact	Without pilot contact
Connection	Screw-terminals

Weight (net)	1364 g
Padlocked	Yes
EAN / identification number	4015394296379
Contact carrier	X-CONTACT®
Cable entry	Top & Bottom 2 x M25 top or bottom closed 1 x M25 and 1 x M32 top or bottom closed

Permissible ambient conditions

Permanent ambient temperature min. - max.	-25 - +55 °C *
---	----------------

Material properties

Hinged lid	PA6/TPE similar RAL 3013 red similar RAL 7016 anthracite
Upper enclosure part	PC/ASA similar RAL 7035 grey
Enclosure base	PC/ASA similar RAL 9005 deep black
Rotary Switch	PC/ASA similar RAL 7035 grey
Material of exterior screws	PA6 similar RAL 9005 deep black

*Specification beyond the standard requirements according to EN 60309-4

Regulations and Standards	
REACH (Regulation (EG) No. 1907/2006)	Information according to article 33 REACH: SVHC: Lead (CAS: 7439-92-1)
RoHS 2011/65/EU incl. 2015/863/EU	✓
POP Regulation (EU) 2019/1021	✓
Norm(s)	DIN EN 60309-4
Declaration of conformity	CE, UKCA
Test mark	VDE, EAC

Dimensional drawing

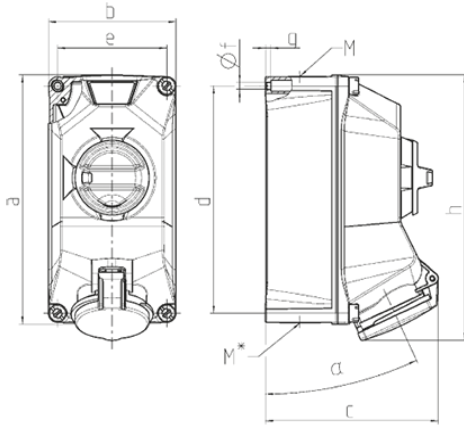

Drawing 1 MB 713	Amp. Poles	16			32		
		3	4	5	3	4	5
Dim. in mm	a	225	225	225	225	225	225
	b	118	118	118	118	118	118
	c	160	160	160	162	162	162
	d	208	208	208	208	208	208
	e	101	101	101	101	101	101
	f	6.4	6.4	6.4	6.4	6.4	6.4
	g	5	5	5	5	5	5
	h	238	244	243	249	249	250
	α	25			25		
	M	1x25 and 1x32			1x25 and 1x32		
	M*	2x25	2x25	2x25	2x25	2x25	2x25
Max. cable diam. (mm)		25	25	25	25	25	25
Terminal for cond. cross section (mm ²) min.-max.		2.5	2.5	2.5	2.5	2.5	2.5
		-10	-10	-10	-10	-10	-10